

Accuphase

PRECISION STEREO PREAMPLIFIER

C-275V

- Current feedback circuit topology assures great sound and stable operation
- Printed circuit boards using Teflon base
- Fully modular construction with separate units for all amplifier stages
- Balanced output stage with bridged feedback
- Complete mono construction with separate left/right transformers
- Logic-controlled relays for shortest signal paths
- Optional analog record playback capability





The new joy of analog – realized in a superb high-end preamplifier. Current feedback technology, Teflon-based printed circuit boards, four separate unit amplifiers, fully dual-mono construction with separate power supplies. Optional phono equalizer unit allows top-quality analog disc reproduction.

All preamplifiers from Accuphase are based on balanced signal transmission, taking a no-compromise approach to quality. Furthermore, they reflect the rich experience accumulated by Accuphase during many years of building state-of-the-art components. The C-275V is a fully redesigned successor to the C-275, making extensive use of sophisticated technology first introduced in the highly renowned C-290V. As an analog preamplifier, it has been honed to an even higher degree of perfection. Every single part was carefully selected through intensive listening tests. It offers a full complement of sound tailoring features such as tone controls and a loudness compensator. The basic circuit design employs current feedback topology developed by Accuphase, assuring outstanding performance combined with excellent sound quality.

As shown in Figure 1, in its standard configuration the C-275V is a dedicated line amplifier, but by installing an optional phono equalizer unit in a special slot on the rear panel, it allows high-grade analog disc reproduction as well.

In keeping with the aim of creating the ideal line amplifier, the balanced output stage of the C-275V employs symmetrically bridged feedback, resulting in a floating design where the signal is kept entirely separate from the ground line. This lavish approach is highly desirable in a line amplifier and assures the best possible performance. The printed circuit boards are an important element of a preamplifier in regards to electrical performance as well as sound quality. In the C-275V, these are made from a Teflon material (glass fluorocarbon resin) with low dielectric constant and low loss, for optimum sound.

Less frequently used controls are located behind a sub panel, and the elegant gold-colored panel face has a stylish appeal. Even in the smallest detail, the C-275V exudes an atmosphere of sheer class which makes this analog preamplifier a joy to own and rapture to listen to.

Current feedback topology prevents phase shifts

The amplifying circuits in the C-275V use the current feedback principle for negative feedback. Figure 2 shows the operating principle of this design. At the input point of the feedback loop, the impedance is

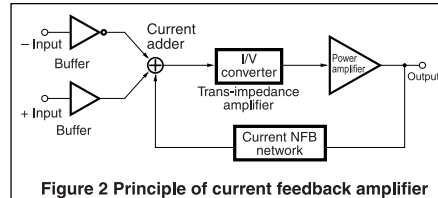

kept low for current detection. A trans-impedance amplifier converts the current into a voltage to be used as the feedback signal. Since the impedance at the current feedback point (current adder in Figure 2) is very low, there is almost no phase shift. Phase compensation therefore can be kept at a minimum. A minimal amount of NFB results in maximum improvement of circuit parameters. The result is excellent transient response and superb sonic transparency, coupled with utterly natural energy balance.

Figure 3 shows frequency response for different gain settings of the current feedback amplifier. The graphs demonstrate that response remains uniform over a wide range.

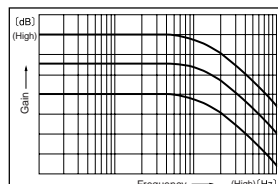

Fig. 3 Frequency response with current feedback (response remains uniform also when gain changes)

Balanced output stage with bridged feedback

In balanced signal transmission, two identical signals are transmitted simultaneously with inverted phase and combined at the receiving end, thereby canceling out common-mode noise and interference. This principle is one of the requirements for truly high-quality sound.

The principle of balanced sound transmission is shown in Figure 4. The outputs of the two amplifiers are connected to form a cross-feedback loop, which sends the symmetrical (+) and (-) signals with low impedance to the next stage. The signals are isolated from the ground line, resulting in an ideal balanced circuit. Even if one side of the output is grounded, both amplifiers continue to operate, and the output voltage does not change.

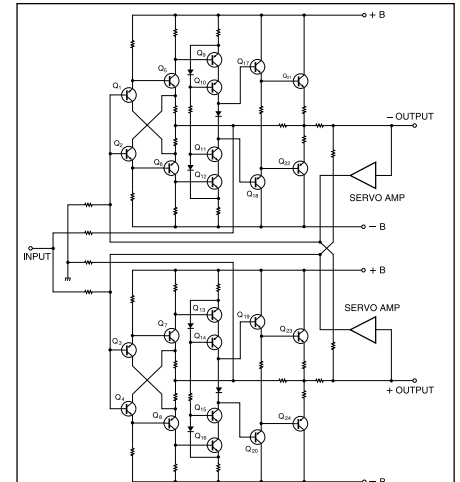

Fig. 4 Principle of balanced signal transmission (one channel)

Discrete line amplifier for optimum sound

The line amplifier is a pure complementary push-pull circuit. It is built from discrete components and employs the superior current feedback principle. Phase compensation can be kept to a minimum, resulting in realistic ambience.

Printed circuit boards made from Teflon with low dielectric constant and low loss

The printed circuit boards for the signal-carrying circuits are made of Teflon, a glass fluorocarbon resin material. Teflon has a stable, low dielectric constant as well as superior heat resistance, excellent high-frequency characteristics, and many other desirable properties. As a result, signal purity is enhanced and there is a drastic improvement in perceived S/N ratio.

* Teflon is a registered trademark of DuPont USA.

Complete mono construction with separate transformers for left and right channels

The power supply of the C-275V employs a dual-mono approach with separate power transformers and filtering capacitors for the two stereo channels. Each unit amplifier is equipped with a wide-range low-impedance voltage regulator to eliminate possible interference between stages.

Tone controls use summing active filters for highest sound quality

The tone control circuitry in the C-275V was specially designed with summing active filters such as found in high-quality graphic equalizers. Figure 5 illustrates the operation principle of

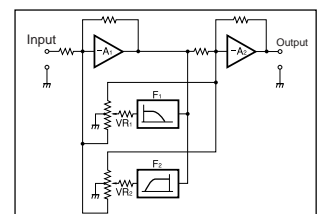

Fig. 5 Principle of tone control circuitry (summing active filter)

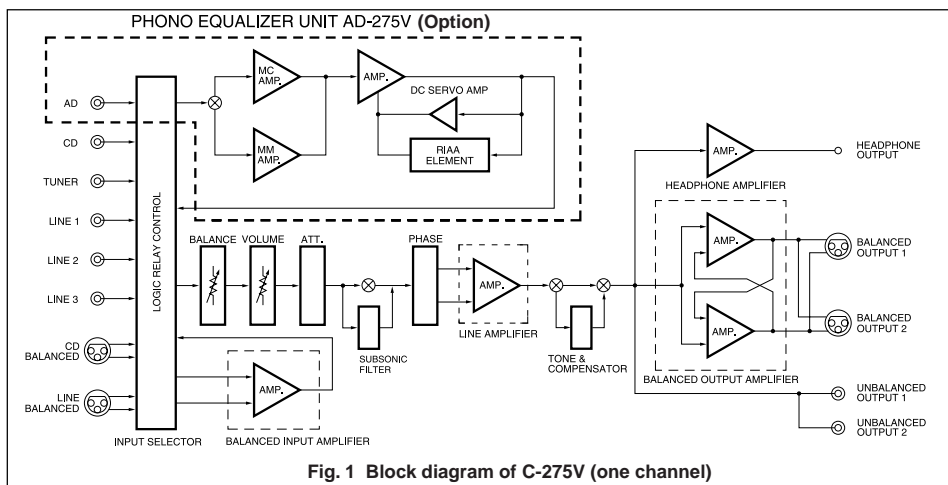
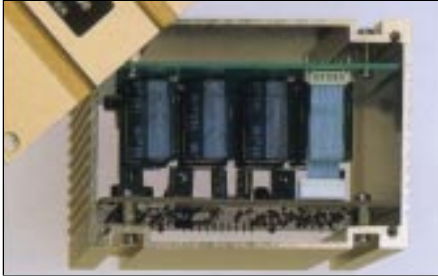

Fig. 1 Block diagram of C-275V (one channel)

this circuit. The flat signal is passed straight through, and only when an adjustment is required, the characteristics are created at F1 and F2 and added to the signal, thereby producing the desired change. This design provides efficient control without degrading signal purity.

Vibration-free design with unit amplifiers in aluminum enclosures fastened to 8-mm hardened aluminum chassis

The C-275V has four unit amplifiers, two each for the line input and line output in each channel. Each unit is powered by its own local voltage regulator circuitry, and is housed in a strong aluminum enclosure, to prevent interference between units.



Unit amplifier in thick aluminum housing

Logic-controlled relays for signal switching assure high sound quality and long-term reliability

The use of logic-controlled relays at strategic locations makes it possible to keep signal paths extremely short. The relays used in the C-275V are high-performance hermetically sealed types as used in professional communication applications. The contacts are twin crossbar types plated with gold and silver palladium alloy, for minimum contact



Hermetically sealed relays connected directly to gold-plated input/output jacks

resistance and outstanding long-term reliability.

Other features

- **Volume control designed for sonic purity**
- **Supplied remote commander for volume adjustment and program source switching**
- **Dedicated headphone amplifier for superior sound**
- **Versatile array of functions**
 - Tape recorder facilities with monitor switch and copy switch
 - Output phase selector button
 - Loudness compensator with three selectable characteristics
 - Subsonic filter removes ultra low frequency noise

- Mother PCB with gold-plated copper paths supports the four unit amplifiers (line and balanced amplifiers), as well as filtering capacitors and peripheral circuitry.

- Remote commander RC-26 allows volume control and input source selection

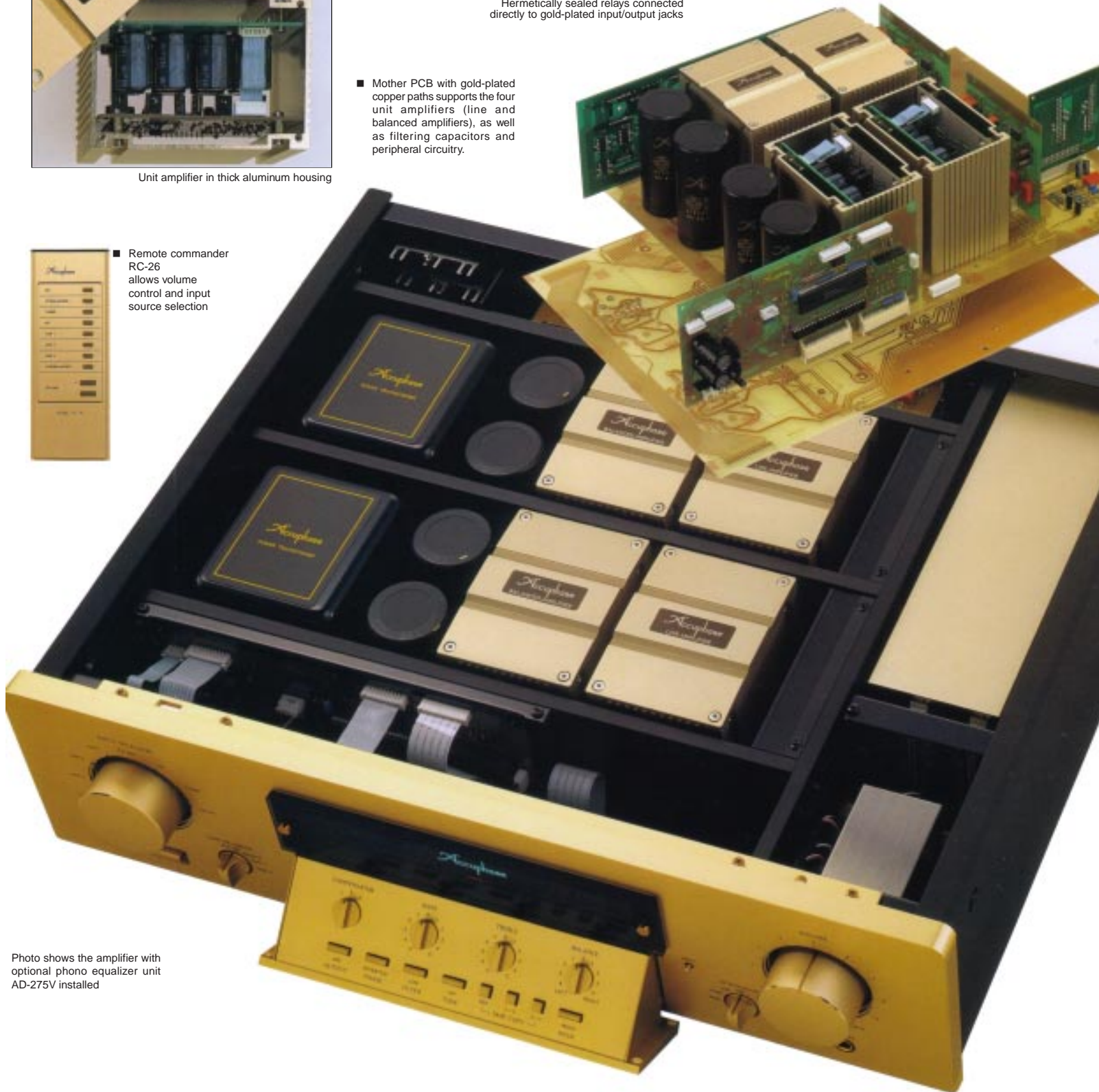

* Photo shows the amplifier with optional phono equalizer unit AD-275V installed

Dedicated Phono Equalizer Unit AD-275V

In its default configuration, the C-275V is a line preamplifier for reproduction of CDs and similar sources. Audiophiles with a collection of analog records will welcome the capability to install the dedicated phono equalizer unit AD-275V in a rear-panel slot, which allows reproduction of analog discs with sonic quality of the highest caliber.

The unit uses printed circuit boards made from Teflon material (glass fluorocarbon resin) and is housed in a sturdy aluminum case for complete protection against any external interference. Highly reliable DIN standard connectors make the shortest possible connection between input and amplification circuits. This assures outstanding S/N ratio. The circuit diagram of the unit is shown below. Dedicated input stages are provided for MM and MC cartridges. To get the best out of each pickup type, the MC input impedance can be switched in three stages (10/30/100 ohms). MM input impedance is fixed to 47 kilohms. To match the output of the cartridge, MC gain can be set to 60 or 66 dB.

- * The AD-275V can only be used in the Accuphase models C-275 or C-275V.
- * The phono equalizer unit AD-275 designed for the Accuphase model C-275 can also be used in the C-275V.

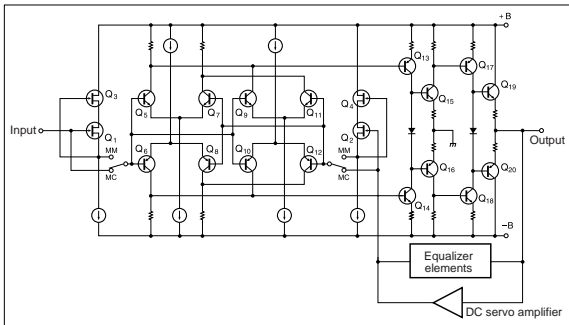

■ Circuit diagram of phono equalizer unit AD-275V (one channel)



■ Phono equalizer amplifier assembly (one channel)



Guaranteed Specifications

- * Guaranteed specifications are measured according to EIA standard RS-490. AD stands for "Analog Disc".
- * Specifications are shown for phono equalizer unit AD-275V installed.

- **Frequency Response** BALANCED/UNBALANCED: 3 - 300,000 Hz +0, -3.0 dB
20 - 20,000 Hz +0, -0.2 dB
AD INPUT: 20 - 20,000 Hz -0.2 dB
- **Total Harmonic Distortion** 0.005% (for all inputs)
- **Input Sensitivity, Impedance**

Input	Sensitivity		Input Impedance
	For rated output	For 0.5 V output	
AD : MM	4.0 mV	1.0 mV	47 kilohms
AD : MC/60 dB	0.25 mV	0.063 mV	10/20/100 ohms
AD : MC/66 dB	0.125 mV	0.0315 mV	10/20/100 ohms
BALANCED	252 mV	63 mV	40 kilohms
UNBALANCED	252 mV	63mV	20 kilohms
- **Output Voltage, Output Impedance**

BALANCED OUTPUT: 2 V, 50 ohms, XLR type connectors
UNBALANCED OUTPUT: 2 V, 50 ohms, RCA type phono connectors
TAPE REC: 252 mV, 200 ohms (with AD input)
- **Signal-to-Noise Ratio**

Input	Input shorted, IHF-A weighting	EIA S/N
	S/N ratio at rated output	
AD : MM	90 dB	91 dB
AD : MC/60 dB	79 dB	84 dB
AD : MC/66 dB	75 dB	84 dB
BALANCED	114 dB	96 dB
UNBALANCED	116 dB	96 dB
- **Maximum Output Level** (0.005% THD, 20 - 20,000 Hz)

BALANCED OUTPUT: 6.0 V, XLR type connectors
UNBALANCED OUTPUT: 6.0 V, RCA type phono connectors
TAPE REC: 6.0 V (with AD input)
- **Maximum AD Input Level** (0.005% THD)

MM INPUT: 125 mV
MC [60/66 dB] INPUT: 8 mV/4 mV
- **Minimum Load Impedance**

BALANCED/UNBALANCED OUTPUT: 600 ohms
TAPE REC: 10 kilohms
- **Gain**

BALANCED/UNBALANCED INPUT → BALANCED/UNBALANCED OUTPUT: 18 dB
BALANCED/UNBALANCED INPUT → REC OUTPUT: 0 dB
AD [MM] INPUT → BALANCED OUTPUT: 54 dB
AD [MM] INPUT → UNBALANCED OUTPUT: 54 dB
AD [MM] INPUT → REC OUTPUT: 36 dB
AD [MC: 60/66 dB] INPUT → BALANCED/UNBALANCED OUTPUT: 78/84 dB
AD [MC: 60/66 dB] INPUT → REC OUTPUT: 60/66 dB
- **Loudness Compensation** 1: +3 dB (100 Hz) 2: +6 dB (100 Hz) 3: +6 dB (100 Hz), +6 dB (20 kHz)
- **Tone Controls** Turnover frequency and adjustment range BASS: 300 Hz ±10 dB (50 Hz) TREBLE: 3 kHz ±10 dB (20 kHz)
- **Subsonic Filter** 25 Hz -12 dB/octave
- **Attenuator Characteristics** -6 dB, -20 dB, -30 dB
- **Headphone Jack** Suitable impedance: 4 - 100 ohms
- **Power Requirements** 120V/230 V (Voltage as indicated on rear panel) AC, 50/60 Hz
- **Power Consumption** 25 watts
- **Maximum Dimensions** Width 475 mm (18-11/16"), Height 150 mm (5-7/8"), Depth 404 mm (15-7/7")
- **Weight** 21.7 kg (47.8 lbs) net, 27.2 kg (60.0 lbs) in shipping carton
- **Supplied Remote Commander RC-26** Remote control principle: infrared pulse
Power supply: 3 V DC (IEC R6 batteries x 2)
Maximum Dimensions: Width 66 mm (2-5/8"), Height 175 mm (6-7/8"), Depth 20 mm (13/16")
Weight: 190 g (419 lbs) (including batteries)

FRONT PANEL

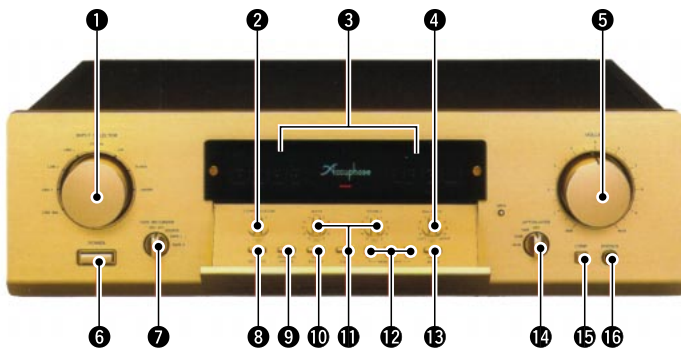

- Input selector
LINE-BAL LINE 3 LINE 2 LINE 1
CD-BAL CD TUNER AD (OP)
- Loudness compensator selector
- Function LED indicators
- Balance control
- Volume control
- Power switch
- Recording output/tape monitor selector
REC OFF SOURCE TAPE 1 TAPE 2
- Output ON/OFF button
- Output phase selector button
- Subsonic filter
- Tone control switch / BASS/TREBLE controls
- Tape copy buttons
OFF 1 → 2 2 → 1
- Stereo/mono selector button
- Attenuator selector
OFF -6 dB -20 dB -30 dB

REAR PANEL (Photo shows the amplifier with optional phono equalizer unit AD-275V installed)

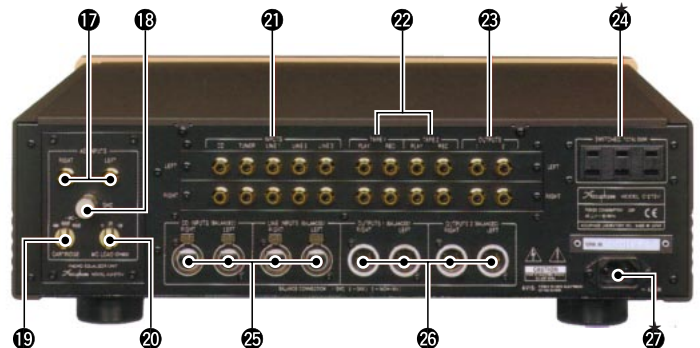

- Loudness compensator ON/OFF switch
- Headphone jack
- AD (Analog Disc) input
- AD ground terminal
- Equalizer gain selector
MM MC/60 dB MC/66 dB
- MC cartridge load impedance selector
10 Ω 30 Ω 100 Ω
- Line inputs
CD TUNER LINE 1,2,3
- Tape recorder REC/PLAY jacks
- Unbalanced outputs
- Switched AC outlets*
- CD/LINE balanced inputs
① GND ② Inverted [-]
③ Non-inverted [+]
- Balanced outputs (2 sets)
① GND ② Inverted [-]
③ Non-inverted [+]
- AC power connector*
(for supplied power cord)

Remarks

- * This product is available in versions for 120/230 V AC. Make sure that the voltage shown on the rear panel matches the AC line voltage in your area.
- * The shape of the AC inlet, plug of the supplied power cord, and AC outlet depends on the voltage rating and destination country.
- * These unswitched AC outlets may not be supplied depending on the safety standards or regulations applicable in the particular country to where the unit is destined.

- Supplied accessories
 - AC power cord
 - Audio cables with RCA plugs
 - Remote commander RC-26



ACCUPHASE LABORATORY INC.

PRINTED IN JAPAN E0010 851-0167-00 (AD1)

* Specifications and design subject to change without notice for improvements.